

PATENT COOPERATION TREATY

PCT

NOTIFICATION OF ELECTION

(PCT Rule 61.2)

From the INTERNATIONAL BUREAU

To:

Commissioner
 US Department of Commerce
 United States Patent and Trademark
 Office, PCT
 2011 South Clark Place Room
 CP2/5C24
 Arlington, VA 22202
 ETATS-UNIS D'AMERIQUE
 in its capacity as elected Office

Date of mailing (day/month/year) 23 May 2001 (23.05.01)	Applicant's or agent's file reference 102837/JPR
International application No. PCT/EP00/09100	Priority date (day/month/year) 14 September 1999 (14.09.99)
International filing date (day/month/year) 13 September 2000 (13.09.00)	
Applicant AHMAVAARA, Kalle	

1. The designated Office is hereby notified of its election made:

in the demand filed with the International Preliminary Examining Authority on:

28 March 2001 (28.03.01)

in a notice effecting later election filed with the International Bureau on:

2. The election was

was not

made before the expiration of 19 months from the priority date or, where Rule 32 applies, within the time limit under Rule 32.2(b).

The International Bureau of WIPO 34, chemin des Colombettes 1211 Geneva 20, Switzerland Facsimile No.: (41-22) 740.14.35	Authorized officer Charlotte ENGER Telephone No.: (41-22) 338.83.38
---	---

PATENT COOPERATION TREATY

PCT

From the INTERNATIONAL BUREAU

NOTIFICATION OF THE RECORDING
OF A CHANGE(PCT Rule 92bis.1 and
Administrative Instructions, Section 422)

To:

RUUSKANEN, Juha-Pekka
Page White & Farrer
54 Doughty Street
London WC1N 2LS
ROYAUME-UNI

Date of mailing (day/month/year) 15 January 2002 (15.01.02)	IMPORTANT NOTIFICATION
Applicant's or agent's file reference 102837/JPR	
International application No. PCT/EP00/09100	International filing date (day/month/year) 13 September 2000 (13.09.00)

1. The following indications appeared on record concerning:

the applicant the inventor the agent the common representative

Name and Address NOKIA NETWORKS OY Keilalahdentie 4 FIN-02150 Espoo Finland	State of Nationality FI	State of Residence FI
	Telephone No.	
	Facsimile No.	
	Teleprinter No.	

2. The International Bureau hereby notifies the applicant that the following change has been recorded concerning:

the person the name the address the nationality the residence

Name and Address NOKIA CORPORATION Keilalahdentie 4 FIN-02150 Espoo Finland	State of Nationality FI	State of Residence FI
	Telephone No.	
	Facsimile No.	
	Teleprinter No.	

3. Further observations, if necessary:

4. A copy of this notification has been sent to:

the receiving Office the designated Offices concerned
 the International Searching Authority the elected Offices concerned
 the International Preliminary Examining Authority other:

The International Bureau of WIPO 34, chemin des Colombettes 1211 Geneva 20, Switzerland Facsimile No.: (41-22) 740.14.35	Authorized officer Beate GIFFO-SCHMITT Telephone No.: (41-22) 338.83.38
---	---

REC'D 27 NOV 2001

INTERNATIONAL PRELIMINARY EXAMINATION REPORT

(PCT Article 36 and Rule 70)



14

Applicant's or agent's file reference 102837/JPR	FOR FURTHER ACTION See Notification of Transmittal of International Preliminary Examination Report (Form PCT/IPEA/416)	
International application No. PCT/EP00/09100	International filing date (day/month/year) 13/09/2000	Priority date (day/month/year) 14/09/1999
International Patent Classification (IPC) or national classification and IPC H04Q7/38		
Applicant NOKIA NETWORKS OY et al.		

- This international preliminary examination report has been prepared by this International Preliminary Examining Authority and is transmitted to the applicant according to Article 36.
- This REPORT consists of a total of 6 sheets, including this cover sheet.
 - This report is also accompanied by ANNEXES, i.e. sheets of the description, claims and/or drawings which have been amended and are the basis for this report and/or sheets containing rectifications made before this Authority (see Rule 70.16 and Section 607 of the Administrative Instructions under the PCT).

These annexes consist of a total of sheets.

- This report contains indications relating to the following items:
 - I Basis of the report
 - II Priority
 - III Non-establishment of opinion with regard to novelty, inventive step and industrial applicability
 - IV Lack of unity of invention
 - V Reasoned statement under Article 35(2) with regard to novelty, inventive step or industrial applicability; citations and explanations supporting such statement
 - VI Certain documents cited
 - VII Certain defects in the international application
 - VIII Certain observations on the international application

Date of submission of the demand 28/03/2001	Date of completion of this report 22.11.2001
Name and mailing address of the international preliminary examining authority:  European Patent Office D-80298 Munich Tel. +49 89 2399 - 0 Tx: 523656 epmu d Fax: +49 89 2399 - 4465	Authorized officer Hodgins, W Telephone No. +49 89 2399 8987 

**INTERNATIONAL PRELIMINARY
EXAMINATION REPORT**

International application No. PCT/EP00/09100

I. Basis of the report

1. With regard to the **elements** of the international application (*Replacement sheets which have been furnished to the receiving Office in response to an invitation under Article 14 are referred to in this report as "originally filed" and are not annexed to this report since they do not contain amendments (Rules 70.16 and 70.17)*):

Description, pages:

1-17 as originally filed

Claims, No.:

1-28 as originally filed

Drawings, sheets:

1/3-3/3 as originally filed

2. With regard to the **language**, all the elements marked above were available or furnished to this Authority in the language in which the international application was filed, unless otherwise indicated under this item.

These elements were available or furnished to this Authority in the following language: , which is:

- the language of a translation furnished for the purposes of the international search (under Rule 23.1(b)).
- the language of publication of the international application (under Rule 48.3(b)).
- the language of a translation furnished for the purposes of international preliminary examination (under Rule 55.2 and/or 55.3).

3. With regard to any **nucleotide and/or amino acid sequence** disclosed in the international application, the international preliminary examination was carried out on the basis of the sequence listing:

- contained in the international application in written form.
- filed together with the international application in computer readable form.
- furnished subsequently to this Authority in written form.
- furnished subsequently to this Authority in computer readable form.
- The statement that the subsequently furnished written sequence listing does not go beyond the disclosure in the international application as filed has been furnished.
- The statement that the information recorded in computer readable form is identical to the written sequence listing has been furnished.

4. The amendments have resulted in the cancellation of:

- the description, pages:
- the claims, Nos.:

**INTERNATIONAL PRELIMINARY
EXAMINATION REPORT**

International application No. PCT/EP00/09100

the drawings, sheets:

5. This report has been established as if (some of) the amendments had not been made, since they have been considered to go beyond the disclosure as filed (Rule 70.2(c)):

(Any replacement sheet containing such amendments must be referred to under item 1 and annexed to this report.)

6. Additional observations, if necessary:

V. Reasoned statement under Article 35(2) with regard to novelty, inventive step or industrial applicability; citations and explanations supporting such statement

1. Statement

Novelty (N)	Yes:	Claims	
	No:	Claims	1-3,5,7,9,15-21,23,25,27,28
Inventive step (IS)	Yes:	Claims	
	No:	Claims	4,6,8,10-14,22,24,26
Industrial applicability (IA)	Yes:	Claims	1-28
	No:	Claims	

2. Citations and explanations
see separate sheet

VI. Certain documents cited

1. Certain published documents (Rule 70.10)

and / or

2. Non-written disclosures (Rule 70.9)

see separate sheet

VII. Certain defects in the international application

The following defects in the form or contents of the international application have been noted:
see separate sheet

Concerning Point V

- 1) The following documents are cited:
D1: EP-A-0 898 438 (NOKIA MOBILE PHONES LTD) 24 February 1999 (1999-02-24)
D2: CH 682 867 A (ASCOM TECH AG) 30 November 1993 (1993-11-30)
D3: WO 99 51051 A (NOKIA TELECOMMUNICATIONS OY ;AHMAVAARA KALLE (FI)) 7 October 1999 (1999-10-07)
- 2) With respect to the subject matter of independent claim 1, D1 discloses a method in a communication system for relocating a protocol termination point (see abstract and passages cited in search report).

The method of D1 comprises:

defining a protocol initialization unit (the "encapsulated messages" shown in figure 7; cf corresponding part of description; see also the "Inter-GRAN handover shown in figure 6) containing predefined information of a first termination point of a first protocol by the first protocol;
transferring the protocol initialization unit from the first termination point (aRNC in figure 7) to a second termination point (bRNC in figure 7) by a second protocol; and
initializing the second termination point based on the protocol initialization unit (column 6 lines 36 - 40).

Accordingly, all features of claim 1 are known from D1 and the claim is thus not novel over D1 and thus fails to meet the requirements of Articles 33(1) and (2) PCT.

- 3) Independent claim 17 relates for the apparatus category to method claim 1. Independent claims 23 and 27 are even broader than claim 17, since they relate merely to one part of the system.

The comments made above apply to these claims also, which are likewise not novel over D1 and thus also fail to meet the requirements of Articles 33(1) and (2) PCT.

- 4) All of the dependent claims are either known from D1 or for the skilled man obvious in the light of D1 (see in particular figures 6 and 7 and related parts of description). Accordingly, they fail to meet the requirements of Articles 33(1) and (2) or (3) PCT.
- 5) It is not at present apparent which part of the application could serve as a basis for a new, allowable claim.

In particular, although the applicant studiously avoids the term, the application essentially relates to handoff in a mobile communications (ie mobile phone) network. It is obvious that, in order to fully support a call, the "replacing network element" must support all protocols of the "replaced" one (and this will equally obviously be more involved in a multimedia UMTS network than in, say, a speech only network). The problem to be solved is thus obvious. Equally obvious is the fact that (either directly or indirectly) the replacing network element must receive the list of required settings (eg protocols) either from the replaced network element or from the mobile station. Since (especially with UMTS) increasing amounts of data are required for this, the latter would use scarce air waves. It is thus obvious to use the former and transfer the data via a link between the two network elements. This is effectively all that the current application describes and claims. Even without the "help" of prior art documents, the skilled man would find this obvious.

- 6) The claimed invention is industrially applicable within the meaning of Articles 33(1) and (4) PCT.

Concerning Point VI

Certain published documents (Rule 70.10 PCT)

Although the above mentioned document D3 (publication date as above, filing date 31.03.99 and priority date 31.03.98) does not constitute prior art within the meaning of Rule 64.1(b) PCT, it seems to be of relevance when considering the novelty of the claims of the current application (see in particular passages cited in search report). No check has been made as to whether the priority of this prior application has been validly claimed.

Concerning Point VII



- 1) The independent claims should have been put in the two part form recommended by Rule 6.3(b) PCT with a pre-characterising part reflecting the teachings of the closest prior art (eg D1).
- 2) In order to meet the requirements of Rule 6.2(b) PCT reference signs in parenthesis should have been added to the claims. This applies both to the preamble and to the characterising part, and to method claims in as far as they refer to apparatus features.
- 3) In order to meet the requirements of Rule 5.1(a)(ii) PCT, at least the document D1 should have been cited in the description and briefly discussed.

PATENT COOPERATION TREATY

PCT

INTERNATIONAL PRELIMINARY EXAMINATION REPORT

(PCT Article 36 and Rule 70)

Applicant's or agent's file reference 102837/JPR	FOR FURTHER ACTION		See Notification of Transmittal of International Preliminary Examination Report (Form PCT/IPEA/416)
International application No. PCT/EP00/09100	International filing date (<i>day/month/year</i>) 13/09/2000	Priority date (<i>day/month/year</i>) 14/09/1999	
International Patent Classification (IPC) or national classification and IPC H04Q7/38			
Applicant NOKIA NETWORKS OY et al.			
<p>1. This international preliminary examination report has been prepared by this International Preliminary Examining Authority and is transmitted to the applicant according to Article 36.</p> <p>2. This REPORT consists of a total of 7 sheets, including this cover sheet.</p> <p><input type="checkbox"/> This report is also accompanied by ANNEXES, i.e. sheets of the description, claims and/or drawings which have been amended and are the basis for this report and/or sheets containing rectifications made before this Authority (see Rule 70.16 and Section 607 of the Administrative Instructions under the PCT).</p> <p>These annexes consist of a total of sheets.</p>			
<p>3. This report contains indications relating to the following items:</p> <p>I <input checked="" type="checkbox"/> Basis of the report</p> <p>II <input type="checkbox"/> Priority</p> <p>III <input type="checkbox"/> Non-establishment of opinion with regard to novelty, inventive step and industrial applicability</p> <p>IV <input type="checkbox"/> Lack of unity of invention</p> <p>V <input checked="" type="checkbox"/> Reasoned statement under Article 35(2) with regard to novelty, inventive step or industrial applicability; citations and explanations supporting such statement</p> <p>VI <input type="checkbox"/> Certain documents cited</p> <p>VII <input type="checkbox"/> Certain defects in the international application</p> <p>VIII <input type="checkbox"/> Certain observations on the international application</p>			
Date of submission of the demand 28/03/2001		Date of completion of this report 05.03.2002	
Name and mailing address of the international preliminary examining authority:  European Patent Office D-80298 Munich Tel. +49 89 2399 - 0 Tlx 523656 epmu d Fax +49 89 2399 - 4465		Authorized officer Hodgins, W Telephone No. +49 89 2399 8987 	

Form PCT/IPEA/409 (cover sheet) (January 1994)

**INTERNATIONAL PRELIMINARY
EXAMINATION REPORT**

International application No. PCT/EP00/09100

1. Basis of the report

1. With regard to the elements of the international application (*Replacement sheets which have been furnished to the receiving Office in response to an invitation under Article 14 are referred to in this report as "originally filed" and are not annexed to this report since they do not contain amendments (Rules 70.16 and 70.17)*):
Description, pages:

1-17 as originally filed

Claims, No.:

1-28 as originally filed

Drawings, sheets:

1/3-3/3 as originally filed

2. With regard to the language, all the elements marked above were available or furnished to this Authority in the language in which the international application was filed, unless otherwise indicated under this item.

These elements were available or furnished to this Authority in the following language: , which is:

- the language of a translation furnished for the purposes of the international search (under Rule 23.1(b)).
- the language of publication of the international application (under Rule 48.3(b)).
- the language of a translation furnished for the purposes of international preliminary examination (under Rule 55.2 and/or 55.3).
3. With regard to any nucleotide and/or amino acid sequence disclosed in the international application, the international preliminary examination was carried out on the basis of the sequence listing:
- contained in the international application in written form.
- filed together with the international application in computer readable form.
- furnished subsequently to this Authority in written form.
- furnished subsequently to this Authority in computer readable form.
- The statement that the subsequently furnished written sequence listing does not go beyond the disclosure in the international application as filed has been furnished.
- The statement that the information recorded in computer readable form is identical to the written sequence listing has been furnished.

4. The amendments have resulted in the cancellation of:

- the description, pages:
- the claims, Nos.:

**INTERNATIONAL PRELIMINARY
EXAMINATION REPORT**

International application No. PCT/EP00/09100

 the drawings, sheets:

5. This report has been established as if (some of) the amendments had not been made, since they have been considered to go beyond the disclosure as filed (Rule 70.2(c)):

(Any replacement sheet containing such amendments must be referred to under item 1 and annexed to this report.)

6. Additional observations, if necessary:

V. Reasoned statement under Article 35(2) with regard to novelty, inventive step or industrial applicability; citations and explanations supporting such statement**1. Statement**

Novelty (N)	Yes: Claims 4,6,8,10-14,22,24,26
	No: Claims 1-3,5,7,9,15-21,23,25,27,28
Inventive step (IS)	Yes: Claims
	No: Claims 4,6,8,10-14,22,24,26
Industrial applicability (IA)	Yes: Claims 1-28
	No: Claims

2. Citations and explanations
see separate sheet

**INTERNATIONAL PRELIMINARY
EXAMINATION REPORT - SEPARATE SHEET**

International application No. PCT/EP00/09100

Concerning Point V

- 1) The following documents are cited:
D1: EP-A-0 898 438 (NOKIA MOBILE PHONES LTD) 24 February 1999 (1999-02-24)
D2: CH 682 867 A (ASCOM TECH AG) 30 November 1993 (1993-11-30)
D3: WO 99 51051 A (NOKIA TELECOMMUNICATIONS OY ;AHMAVAARA KALLE (FI)) 7 October 1999 (1999-10-07)

- 2) Having carefully considered the applicant's arguments in the current case, the International Examining Authority has come to the conclusions set out below.

Although the applicant studiously avoids the term, the application essentially relates to handoff in a mobile communications (ie mobile phone) network. It is obvious that, in order to fully support a call, the "replacing network element" must support all protocols of the "replaced" one (and this will equally obviously be more involved in a multimedia UMTS network than in, say, a speech only network). The problem to be solved (as stated for example on page 10 lines 14 - 21) is thus obvious. Equally obvious is the fact that (either directly or indirectly) the replacing network element must receive the list of required settings (eg protocols) either from the replaced network element or from the mobile station. Since (especially with UMTS) increasing amounts of data are required for this, the latter would use scarce air waves. It is thus obvious to use the former and transfer the data via a link between the two network elements. This is effectively all that the current application describes and claims. Even without the "help" of prior art documents, the skilled man would find this obvious.

It is equally obvious that for any communications link (wired or wireless), protocols are used. The two ends of any communications link are thus protocol termination points. In fact, in the broad manner used in the current application, "protocol" could even be viewed as being synonymous to "communication". Moreover, as used in the discussion relating to figure 4 (page 11 line 29 - page 14 line 24) it is not even clear if the first and second protocols are actually different. However, regardless of this, what seems to be central to the current invention is that handoff of a mobile station MS 6 occurs from RNC 10 to RNC 11 (or more precisely from

**INTERNATIONAL PRELIMINARY
EXAMINATION REPORT - SEPARATE SHEET**

International application No. PCT/EP00/09100

RRC 24 in RNC 10 to RRC 26 in RNC 11). The protocol settings required by RRC 26 are sent from RRC 24 in an encapsulated message either by link 18 or via core network 14. Since these are wired, the protocol used on these will be different from that between the MS and the RNCs (RRCs). This is, however, exactly what happens in D1.

In this respect D1 discloses a method in a communication system for relocating a protocol termination point (see abstract and passages cited in search report).

The method of D1 comprises

defining a protocol initialization unit (the "encapsulated messages" shown in figure 7; cf corresponding part of description; see also the "Inter-GRAN handover shown in figure 6) containing predefined information of a first termination point of a first protocol by the first protocol;
transferring the protocol initialization unit from the first termination point (aRNC in figure 7) to a second termination point (bRNC in figure 7) by a second protocol; and
initializing the second termination point based on the protocol initialization unit (column 6 lines 36 - 40).

Accordingly, all features of claim 1 are known from D1 and the claim is thus not novel over D1 and thus fails to meet the requirements of Articles 33(1) and (2) PCT.

What the applicant seems to find of particular importance is the feature probably meant to be reflected in the claim language "of a first protocol by the first protocol". What exactly this wording means is not quite understood. It is, however, pointed out that the "protocol initialization unit" of D1 (ie the message sent from the first to the second RNC) is an encapsulated message. Moreover, even if the applicant were able, on the basis of such a detail to establish that claim 1 is novel, it is clear that, in such a case, the skilled man would be able to arrive at the claimed subject matter without performing an inventive step. In such a case, claim 1 would fail to meet the requirements of Articles 33(1) and (3) PCT.

**INTERNATIONAL PRELIMINARY
EXAMINATION REPORT - SEPARATE SHEET**

International application No. PCT/EP00/09100

- 3) Independent claim 17 relates for the apparatus category to method claim 1. Independent claims 23 and 27 are even broader than claim 17, since they relate merely to one part of the system.

The comments made above apply to these claims also, which are likewise not novel (or at the very least not inventive) over D1 and thus also fail to meet the requirements of Articles 33(1) and (2) PCT.

- 4) All of the dependent claims are either known from D1 or for the skilled man obvious in the light of D1 (see in particular figures 6 and 7 and related parts of description). Accordingly, they fail to meet the requirements of Articles 33(1) and (2) or (3) PCT.
- 5) The claimed invention is industrially applicable within the meaning of Articles 33(1) and (4) PCT.
- 6) For the sake of completeness, the following is noted:
- i) Certain published documents (Rule 70.10 PCT)

Although the above mentioned document D3 (publication date as above, filing date 31.03.99 and priority date 31.03.98) does not constitute prior art within the meaning of Rule 64.1(b) PCT, it seems to be of relevance when considering the novelty of the claims of the current application (see in particular passages cited in search report). No check has been made as to whether the priority of this prior application has been validly claimed.

- ii) The independent claims should have been put in the two part form recommended by Rule 6.3(b) PCT with a pre-characterising part reflecting the teachings of the closest prior art (eg D1).
- iii) In order to meet the requirements of Rule 6.2(b) PCT reference signs in parenthesis should have been added to the claims. This applies both to the preamble and to the characterising part, and to method claims in as far as they refer to apparatus features.

**INTERNATIONAL PRELIMINARY
EXAMINATION REPORT - SEPARATE SHEET**International application No. PCT/EP00/09100

- iv) In order to meet the requirements of Rule 5.1(a)(ii) PCT, at least the document D1 should have been cited in the description and briefly discussed.

(19) World Intellectual Property Organization
International Bureau



(43) International Publication Date
22 March 2001 (22.03.2001)

PCT

(10) International Publication Number
WO 01/20938 A1

- (51) International Patent Classification⁷: H04Q 7/38
- (21) International Application Number: PCT/EP00/09100
- (22) International Filing Date:
13 September 2000 (13.09.2000)
- (25) Filing Language: English
- (26) Publication Language: English
- (30) Priority Data:
9921706.9 14 September 1999 (14.09.1999) GB
- (71) Applicant (for all designated States except US): NOKIA NETWORKS OY [FI/FI]; Keilalahdentie 4, FIN-02150 Espoo (FI).
- (72) Inventor; and
- (75) Inventor/Applicant (for US only): AHMAVAARA, Kalle [FI/JP]; Nokia Japan Co Ltd, 2-13-5, Nagata-cho, Chiyoda-ku, Tokyo 100-0014 (JP).
- (74) Agents: RUUSKANEN, Juha-Pekka et al.; Page White & Farrer, 54 Doughty Street, London WC1N 2LS (GB).
- (81) Designated States (national): AE, AG, AL, AM, AT, AU, AZ, BA, BB, BG, BR, BY, BZ, CA, CH, CN, CR, CU, CZ, DE, DK, DM, DZ, EE, ES, FI, GB, GD, GE, GH, GM, HR, HU, ID, IL, IN, IS, JP, KE, KG, KP, KR, KZ, LC, LK, LR, LS, LT, LU, LV, MA, MD, MG, MK, MN, MW, MX, MZ, NO, NZ, PL, PT, RO, RU, SD, SE, SG, SI, SK, SL, TJ, TM, TR, TT, TZ, UA, UG, US, UZ, VN, YU, ZA, ZW.
- (84) Designated States (regional): ARIPO patent (GH, GM, KE, LS, MW, MZ, SD, SL, SZ, TZ, UG, ZW), Eurasian patent (AM, AZ, BY, KG, KZ, MD, RU, TJ, TM), European

[Continued on next page]

(54) Title: RELOCACIÓN IN A COMMUNICATION SYSTEM

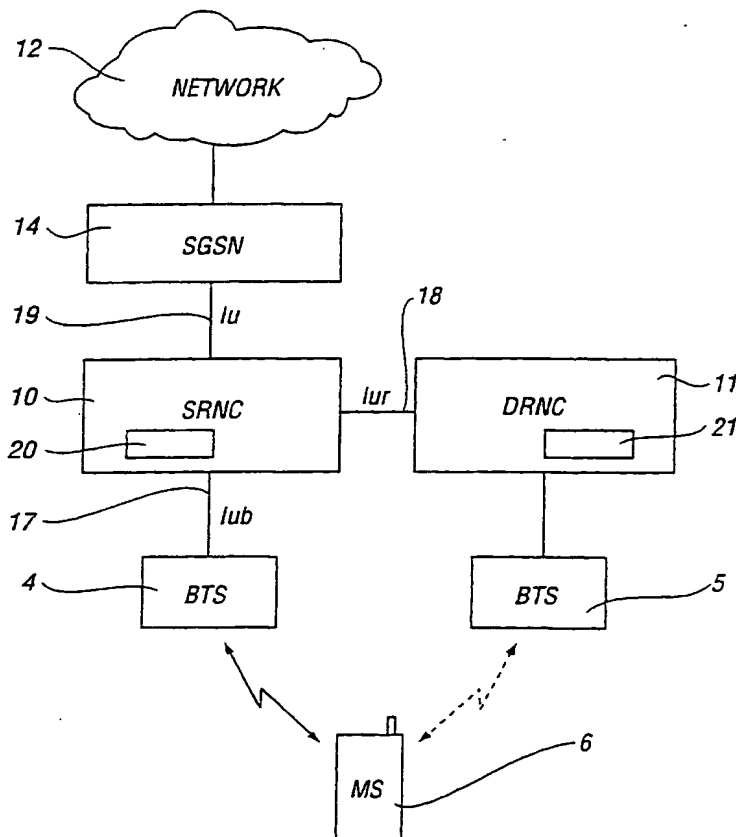

(57) Abstract: The present invention relates to relocation of a protocol termination point in a communication system comprising a first protocol termination point, a second protocol termination point and control means for relocating a first protocol from the first protocol termination point to the second protocol termination point. A protocol initialization unit that contains predefined information of the first termination point is defined by means of the first protocol. The protocol initialization unit is subsequently transferred from the first termination point to the second termination point by means of a second protocol. The second termination point is initialized based on the received protocol initialization unit.

WO 01/20938 A1



patent (AT, BE, CH, CY, DE, DK, ES, FI, FR, GB, GR, IE, IT, LU, MC, NL, PT, SE), OAPI patent (BF, BJ, CF, CG, CI, CM, GA, GN, GW, ML, MR, NE, SN, TD, TG).

For two-letter codes and other abbreviations, refer to the "Guidance Notes on Codes and Abbreviations" appearing at the beginning of each regular issue of the PCT Gazette.

Published:

— *With international search report.*

Relocation in a communication system

Field of the Invention

5 The present invention relates to relocation in a communication system and in particular, but not exclusively, to relocation of a protocol termination point.

Background of the Invention

10

Communication networks typically operate in accordance with a given standard which sets out what the elements of the network are permitted to do and how that should be achieved. The communication in the networks follows predefined rules which are referred to in the following as protocols. The protocols to be used are defined in the associated standard. The protocols can be used for controlling various events and functionalities in a connection provided through the communications network. Several protocols may be simultaneously in an active state for providing control of a connection. During an ongoing i.e. active connection a protocol is having a termination point in the network element controlling the connection. For example, a protocol may have termination points in a telephone terminal and in a network controller controlling the connection.

25

A communication network is a cellular radio network consisting of cells. In most cases the cell can be defined as a certain area covered by one or several base transceiver stations (BTS) serving mobile stations (MS) via a radio interface and connected to a base station subsystem (BSS). Several cells cover a larger area, and form the coverage area of a cellular

30

radio network. The cell (or group of cells) and thus the mobile station (MS) or similar user equipment (UE) within one of the cells of the system can be controlled by a node providing controller functionality, for example by a radio network controller (RNC) or a mobile switching center (MSC).
5 The controller can be connected further to a gateway or linking node, for example a gateway GPRS support node (GGSN) or gateway mobile switching center (GSMC), linking the cell to the other parts of the communication system and/or other
10 communication networks, such as to a PSTN (Public Switched Telecommunications Network) or to a data network, such as to a X.25 based network or to a TCP/IP (Transmission Control Protocol/Internet Protocol) based network.

15 The mobile station MS may be controlled by only one controller at time. However, the MS may also be simultaneously controlled by several controller nodes. This may occur e.g. when the cells overlap or in so called soft handoff mode, where the MS may be in communication with two base stations and those base
20 stations may be connected to different controllers, or when one controller is controlling another controller controlling the MS. One controller of the plurality of controllers in the system can be defined as a serving (main) controller whereas the others may act as secondary controllers. The
25 responsibility of controlling a connection between the mobile station and the network may change during an ongoing connection. It is therefore necessary to relocate at least part of functionalities associated with the connection such that the connection will not become disconnected and/or that
30 the quality of the connection remains in an acceptable level. It is to be appreciated that in addition or as an alternative to relocating functionalities of the controller node, the

functionality to be relocated may also be located in any other of the network elements, for example in the base station, base station subsystem, in the gateway and so on.

- 5 When relocation is decided to be performed, the serving controller or another node of the communication system may initiate the necessary proceeding for replacing one or several of the network nodes with a new corresponding node or nodes..
- 10 In case of an active i.e. ongoing connection, one of the features that should to be relocated is the state of a protocol termination point. Although it is not always necessary, in a usual case the status of the protocol termination point at the new "replacing" network element or
- 15 node should be such that it may take over the functions of the old "replaced" network node. At the present the parameters which need to be transferred have to be defined also in the protocols which are used to convey the information from the old termination point to the new termination point. For
- 20 example, if parameters of a Radio Resource Control (RRC) or Medium Access Control (MAC) or Radio Link Control (RLC) protocols are to be relocated in a system that would use radio network subsystem application part (RNSAP) for communication between the network controller nodes, this would mean that a
- 25 lot of "external" parameters would have to be defined for the RNSAP. This would increase the complexity of the RNSAP. In addition, if several additional parameters of a protocol are to be defined for the another protocol, it makes these two different protocols very dependent on each other. The
- 30 independent evolution of them would thus become more difficult to manage.

Summary of the Invention

It is an aim of the embodiments of the present invention to address one or several of the above problems.

5

According to one aspect of the present invention, there is provided a method in a communication system for relocating a protocol termination point, comprising:

10 defining a protocol initialization unit containing predefined information of a first termination point of a first protocol by the first protocol;

transferring the protocol initialization unit from the first termination point to a second termination point by a second protocol; and

15 initializing the second termination point based on the protocol initialization unit.

According to another aspect of the present invention there is provided a communication system, comprising:

20 a first protocol termination point;

a second protocol termination point;

control means for relocating a first protocol from the first protocol termination point to the second protocol termination point, said control means being arranged to form a protocol initialization unit containing predefined information of the first protocol at the first protocol termination point;

25 communication path based on a second protocol between the first and the second termination points for transferring the protocol initialization unit; and

30 control means for initializing the second protocol termination point based on the protocol initialization unit.

According to a still another aspect of the present invention there is provided a network element for use in a communication network, comprising:

a protocol termination point;

5 control means for relocating a first protocol from the protocol termination point to another protocol termination point, said control means being arranged to form a protocol initialization unit containing predefined information of the first protocol at the protocol termination point; and

10 interface to said other protocol termination point based on a second protocol for transferring the protocol initialization unit from the first termination point by means of the second protocol.

15 According to a still another aspect of the present invention there is provided a network element for use in a communication network, comprising:

a protocol termination point of a first protocol;

20 interface to another protocol termination point for receiving a protocol initialization unit containing predefined information of the first protocol at said other termination point, wherein the interface is based on a second protocol; and

25 control means for initializing the protocol termination point based on the received protocol initialization unit.

According to a more specific embodiment, the protocol initialization unit may contain state information of the first protocol termination point.

30 The first termination point may also be located at a first network element of the communication system and the second

termination point may be located at a second network element of the communication system. The second network element may, upon receiving the protocol information unit, generate and transmit a response to the first network element by means of the second protocol.

The protocol initialization unit may be encapsulated in a message transmitted between the first termination point and the second termination point. The protocol initialization unit may also be transparent for the second protocol.

The protocol initialization unit may be transmitted via a network element of a core network of the communication system. This may be accomplished by means of a radio access network application part (RANAP) protocol. According to an embodiment, the protocol initialization unit may be transmitted directly between the termination points. This may be accomplished by means of a radio network subsystem application part (RNSAP) protocol.

The protocol initialization unit may contain information of at least one further protocol. According to an embodiment at least one further protocol initialization unit may be defined containing predefined information of a further protocol by the further protocol, whereafter the further protocol initialization unit is transferred from the first termination point to the second termination point. The further protocol initialization unit may be transferred between the termination points by a protocol that is different to the second protocol.

The parameters of the second termination point may be set into a state that is relatively similar to the state of parameters

of the first termination point before or at the time the relocation procedure was initiated during the initialization procedure.

5 The embodiments of the invention provide several advantages. One of the benefits is that a need for defining a great number of parameters of one protocol in another protocol is avoided. This provides clear benefits in updating and maintenance of the protocols.

10

Brief Description of Drawings

For better understanding of the present invention, reference will now be made by way of example to the accompanying
15 drawings in which:

Figure 1 shows a schematic diagram of a cellular radio network system in which embodiments of the invention can be implemented;

20 Figure 2 shows the hierarchy of various elements of the network of Figure 1;

Figure 3 shows two possible interfaces between network nodes; and

25 Figure 4 is a flow chart for operation in accordance with one embodiment.

30

Description of Preferred Embodiments of the Invention

Reference will be first made to Figure 1 in which three cells 1,2,3 of a cellular telecommunications network are shown. Each
30 cell 1,2,3 is served by a respective base transceiver station (BTS) 4',4,5. Each base transceiver station (BTS) is arranged to transmit signals to and receive signals from the mobile

stations (MS) 6 located in the cell associated with the given base transceiver station. Likewise, each mobile station 6 is able to transmit signals to and receive signals from the respective base transceiver station 4', 4, 5, and also able to
5 move from the coverage area of one cell to the coverage area of another cell, e.g. from cell 2 to cell 3.

The exemplifying cellular telecommunications network will be described in more detail in the following by using the
10 terminology of a proposed Universal Mobile Telecommunications System (UMTS) standard. However, it is to be appreciated that the invention is not restricted to UMTS but can be implemented in any standard. Examples of these include, without any intention to restrict the possible communication systems to
15 these, any of the code division multiple access (CDMA) based systems or any of the time division multiple access (TDMA) based systems or any of the frequency division multiple access (FDMA) based systems or any hybrids thereof.

20 Reference is now made to Figure 2 which shows the hierarchy of a cellular communication system. As can be seen, the mobile station 6 is in wireless communication with one of the base stations. Typically a number of mobile stations will be in communication with each base station although only one mobile
25 station is shown in Figure 2 for clarity. A first base station 4 is connected to a first network controller, which in Figure 2 is a serving radio network controller SRNC 10. Again, more than one base station is usually connected to each controller 10 although only one is shown for clarity. Typically more than
30 one controller is also provided in a network. The SRNC 10 is connected to other elements of the network 12 via a suitable

linking or gateway apparatus, such as a serving GPRS (General Packet radio Service) Support Node (SGSN) 14.

5 The SRNC 10 is arranged to control the base station, either directly or through an intermediate node (not shown). The controller 10 passes on data to be transmitted to the mobile station by the base station. The controller 10 will also receive from the base station data which the base station has received from the mobile station. The implementation of the
10 communication between the base station, the mobile station and the controller is known, and will thus not be discussed in detail herein. It is sufficient to note that the interface may comprise channels in both uplink and downlink directions. The data may be sent between the mobile station and the controller
15 in any suitable format. The messages sent from the mobile stations may include information identifying the mobile station (for instance, MS ID and/or IMSI (Mobile Station Identity and/or International Mobile Subscriber Identity, respectively)).

20 In addition to the serving controller (RNC 10), the cellular telecommunications system of Figure 2 includes another controller RNC 11 controlling the base station 5 of cell 3 of Figure 2. It is, again, noted that the second controller may
25 also control more than one base station. The second controller may also sometimes be referred to as a drift controller (DRNC). The SNRC 10 and DRNC 11 may communicate with each other over an open Iur interface 18 established between them.

30 Figure 2 illustrates one possible relocation situation wherein the mobile station MS 6 or similar user equipment communicates firstly via the BTS 4 over a radio interface designated by a

solid line and then switches to communicate via a new BTS 5, as designated by the dashed radio interface. According to one possibility the change from one base station to another may occur after the mobile station 6 has moved into the service or illumination area of the second base station 5. However, it is to be appreciated that in addition to the movement of the mobile station, there are also other possible reasons for triggering the relocation of the connection to another base station or to another network element, such as network optimization, load balancing, hardware congestion, connection quality improvement, fault in the system or base station and so on.

In order to ensure a proper operation of the system and to avoid disconnecting a possibly ongoing call, at least some of the functionalities of the network elements have to be relocated for the connection. For example, when a SRNC functionality is to be located from a first RNC to a second RNC some protocol termination points of an ongoing connection (such as RRC, RCL and/or MAC protocols) need to be changed from the first RNC to the second RNC.

Before explaining an embodiment for the relocation in more detail, a brief explanation will be given of the protocol termination point with reference to Figure 3 showing a block diagram of the source RNC 10 and the target RNC 11. The exemplifying protocol termination point is illustrated to comprise a radio resource control (RRC) protocol. However, it is to be appreciated that the described RRC protocol is only an example, and that the embodiments can be implemented for any other protocol used for a connection in a communication system as well. These other protocols include, without any

restriction to these, medium access control (MAC) protocol, radio link control (RLC) protocol and packet data convergence protocol (PDCP).

5 The SRNC 10 and DRNC 11 each are provided with a Radio Resource Controller functionality RRC 24 and 26, respectively. When the MS 6 is communication with the controller 10, the RRC protocol has its other termination point correspondingly at the controller 10, while the other termination point is at the
10 mobile station. However, should the controller change, the termination point of the RRC protocol should also be changed correspondingly. More precisely, the new controller 11 should be provided with a similar termination point functionality using similar parameters as the previous controller had. These
15 functionalities will be controlled by a control unit 20 at the source controller 10 and by a control unit 21 at the target controller 11.

Figure 3 shows further an Iur interface 18 between the DRNC 10
20 and the SRNC 11. For example, a RNSAP (Radio Network Subsystem Application Part) protocol can be used for the direct signalling between the two RNCs. A RANAP (Radio Access Network Application Part; in the control plane) protocol can be used for L3 (Layer 3) signalling over the Iu interface between the RNCs
25 and an appropriate element 14 of the core network 14. The core network element 14 can be e.g. a mobile switching center or a serving GPRS support node.

A reference will now be made to the flow chart of Figure 4
30 showing in more detail an embodiment for moving the required state information of a protocol termination point from one termination point at a first network element (NE) to another

termination point in a second network element. As illustrated by step 30, the protocol termination point is to be moved between the termination points during an active state of the protocol between the servicing network controller and the mobile station. After the relocation procedures are initiated at step 32, the "old" protocol termination point in the source network element produces at step 34 a special protocol data unit (PDU) containing predefined necessary protocol parameters for initialization of the second termination point before relocation of the connection. The PDU is passed at step 36 to the new termination point with help of a second protocol. The second protocol is used for signaling between the different network elements or nodes. The passed information can be transparent to the second protocol used for the transmission of the PDU. Examples of the protocols which may be used for the transmission of the PDU will be discussed in more detail later in this specification. The new termination point receives the PDU and it is initialized at step 38 based on the information received from the old termination point. After the initialization procedure the termination point will be relocated at step 40 to the new network element and the operation of the system continues as before except that the protocol termination point of the active protocol is now situated in the new network element.

In other words, an explicit protocol message will be passed between the old termination point and the new termination point of a protocol in case of relocation of the protocol termination point. The specified PDU (or message) is used within a protocol peer between the old and the new termination point of the protocol. In a preferred embodiment a single protocol defines the information to be transferred between the

protocol peers and the information to be transmitted within one peer. By means of this it is possible to avoid a need for defining a great number of parameters of one protocol in another protocol. For example, by the embodiment described in
5 the following about 100 RRC parameters in the RANAP protocol are avoided.

Referring again to Figure 3, a more detailed example of the relocation procedure will now be given in context of
10 relocating a radio interface L3 protocol (i.e. a radio resource control; RRC) protocol from a first or source controller (e.g. RNC 10 of Figure 3) to a second or target controller (e.g. RNC 11 of Figure 3). The exemplifying RRC protocol is known, and is not described in more detail. It is
15 sufficient to note that the RRC provides common controlling and signaling over the air interface between the serving RNC and the mobile station and that the RRC can be shared with circuit switched traffic and packet switched traffic.

20 The control unit 20 of the first (source) RNC 10 produces the special protocol initialization unit which in this instance will be referred to as a RRC PDU. The RRC PDU contains all such predefined RRC parameters that have to be known by the new termination point in order to receive and continue the
25 connection. These parameters may include information concerning e.g. one or several of the following: radio bearer(s), transport channel(s), radio link(s) and their physical channels, capability information as well as user equipment capabilities and measurements being reported by the
30 user equipment and so on. According to a preferred embodiment the RRC PDU contains all such RRC parameters that are required by the termination point at the target RNC to start the RRC

protocol in a relatively similar state and conditions that existed in the old termination point.

According to an embodiment the generated RRC PDU can be
5 transferred from the first RNC to the second RNC by means of a
RNSAP (Radio Network Subsystem Application Part) over an open
interface Iur 18 provided between the first controller 10 and
the second controller 11. The termination point at the second
RNC receives the RRC PDU and subsequently decodes the received
10 RRC PDU. The termination point 26 is initialized based on the
received and decoded information. The initialization procedure
can be controlled by the control unit 21.

According to another embodiment the PDU is firstly moved from
15 the source RNC 10 to the core network (CN) 14 over an Iu
interface 19 by a RANAP (Radio Access Network Application
Part) message 'RELOCATION REQUIRED' and subsequently from the
core network to the target RNC 11 by an Iu RANAP message
'RELOCATION REQUEST'.
20

The RRC PDU can be encapsulated within a message in the second
protocol as there is no need for the contents of the RRC PDU
to be visible for the functionality of the second protocol,
such as to the RANAP or the RNSAP. The encapsulation of
25 protocol messages transparently to a message of another
protocol is a known technique and will thus not be discussed
in more detail herein

It should be appreciated that the status of any other
30 protocol, such as the MAC protocol or RLC protocol referred to
above, could also be conveyed by the RRC protocol. In more
general terms, a protocol may "collect" required information

for several protocols and generate a PDU containing required information for all or at least more than one of the protocols to be relocated. According to an embodiment a separate or further protocol initialization unit PDU is used for each of
5 the protocols to be relocated or at least some of the protocols to be relocated. The different protocol initialization units can be transferred between the termination point by protocols that are different to each other.

10

It should also be appreciated that some embodiments do not require an identical or relatively similar protocol termination point at the old and the new network element. However, it is preferred that the information included in the
15 protocol initialization unit is such that that the functionalities of the communication system may continue without disconnecting the user equipment from the communication system.

20 According to one possibility the termination point is not relocated from a network element or node to another node but within the node.

It is noted that in some embodiments of the invention, the
25 relocation of some or all functionalities may also be triggered even in such conditions where the communication could continue without any relocation proceedings, e.g. in order to optimize the operation of the system or balance the load distribution in the system. In addition, the mobile
30 station 6 of Figure 2 may be in communication with both controllers 10 and 11. Furthermore, it may not be necessary to relocate the entire protocol or all protocols used for a

connection, but instead only a part of the information concerning the protocols is transmitted between the network elements. For example, a user plane communication may be enabled via the Iur interface 18 of Figure 2, whereby the
5 mobile station 6 within the service area of the controller 11 could still be controlled by the old servicing controller 10 via the controller 11.

According to a further embodiment the initialization is a bi-
10 directional process. In other words, instead of only transmitting information from the first network element (node) to the second element, the new network element may send a respond to the first element or accomplish a transmission to a further network element. The respond may include a message
15 such as "unable to initialize", "overload", "all parameters not received" and so on. Upon receiving the response, the first network element may modify its state and/or take some other actions towards the new termination point. For example, transmit modified parameter or parameters, or use different
20 transmission route, or try to relocate the connection to another network element.

It should also be appreciated that whilst embodiments of the present invention have been described in relation to a
25 connection between the network nodes and a mobile station, embodiments of the present invention are applicable to any other suitable type of connections terminating to one node. It should also be appreciated that base stations can sometimes be referred to as node B.

30 There are also other possible reasons for initiating the relocation procedure that movement of the mobile station into a new service area. For example, the network element in

question may become overloaded or a failure in the system of the network element itself may force the system to relocate at least a part of the functionalities, network optimization, load balancing and so on.

5

The exemplifying embodiments of the invention have discussed protocols terminated to a network controller. Embodiments of the present invention can be applicable to other network elements as well where applicable.

10

It is also noted herein that while the above describes one exemplifying embodiment of the invention, there are several variations and modifications which may be made to the disclosed solution without departing from the scope of the present invention as defined in the appended claims.

15

Claims

1. A method in a communication system for relocating a protocol termination point, comprising:
 - 5 defining a protocol initialization unit containing predefined information of a first termination point of a first protocol by the first protocol;
 - transferring the protocol initialization unit from the first termination point to a second termination point by a
 - 10 second protocol; and
 - initializing the second termination point based on the protocol initialization unit.
2. A method according to claim 1, wherein the protocol
- 15 initialization unit contains state information of the first protocol termination point.
3. A method according to claim 1 or 2, wherein the first termination point is located at a first network element of the
- 20 communication system and the second termination point is located at a second network element of the communication system.
4. A method according to claim 3, wherein the second network
- 25 element, upon receiving the protocol information unit, generates and transmits a response to the first network element by means of the second protocol.
5. A method according to any of the preceding claims,
- 30 wherein the protocol initialization unit is encapsulated in a message transmitted between the first termination point and the second termination point by the second protocol.

6. A method according to any of the preceding claims, wherein the protocol initialization unit is transparent for the second protocol.

5

7. A method according to any of the preceding claims, wherein the protocol initialization unit is transmitted via a third network element between the termination points.

10 8. A method according to claim 7, wherein the transmission is based on a radio access network application part (RANAP) protocol.

15 9. A method according to any of claims 1 to 6, wherein the protocol initialization unit is transmitted by a direct connection between the termination points.

20 10. A method according to claim 9, wherein the transmission is based on a radio network subsystem application part (RNSAP) protocol.

25 11. A method according to any of the preceding claims, wherein the predefined information of the first protocol comprise one or several parameters of a radio resource control protocol (RRC), medium access control protocol (MAC), radio link control protocol (RLC), and/or packet data convergence protocol (PDCP).

30 12. A method according to any of the preceding claims, wherein the protocol initialization unit contains information of at least one further protocol.

13. A method according to any of the preceding claims,
comprising steps of:

defining at least one further protocol initialization
unit containing predefined information of a further protocol
5 by the further protocol; and

transferring the further protocol initialization unit
from the first termination point to the second termination
point.

10 14. A method according to claim 13, wherein the further
protocol initialization unit is transferred between the
termination points by a protocol that is different to the
second protocol.

15 15. A method according to any of the preceding claims,
wherein at least one of the termination points is located at
one of the following: a base station controller, a radio
network controller, a base station, a gateway.

20 16. A method according to any of the preceding claims,
wherein the step of initializing the second termination point
comprises setting the parameters of the second termination
point into a state that is similar to the parameters of the
first termination point before or at the time the relocation
25 procedure was initiated.

17. A communication system, comprising:

a first protocol termination point;
a second protocol termination point;

30 control means for relocating a first protocol from the
first protocol termination point to the second protocol
termination point, said control means being arranged to form a

protocol initialization unit containing predefined information of the first protocol at the first protocol termination point;

communication path based on a second protocol between the first and the second termination points for transferring the protocol initialization unit; and

control means for initializing the second protocol termination point based on the protocol initialization unit.

18. A communication system according to claim 17, wherein the protocol initialization unit contains state information of the first protocol termination point.

19. A communication system according to claim 17 or 18, wherein the control means for relocating are arranged to encapsulate the protocol initialization unit into a message to be transmitted from the first termination point to the second termination point.

20. A communication system according to any of claims 17 to 19, wherein the first termination point is located at a first network element of the communication system and the control means for relocating are arranged in connection with the first network element.

21. A communication system according to any of claims 17 to 20, wherein the second termination point is located at a second network element of the communication system and the control means for initializing are arranged in connection with the second network element.

22. A communication system according to any of the claims 17 to 21, wherein the protocol initialization unit contains information of at least one further protocol.

5 23. A network element for use in a communication network, comprising:

a protocol termination point;

control means for relocating a first protocol from the protocol termination point to another protocol termination point, said control means being arranged to form a protocol
10 initialization unit containing predefined information of the first protocol at the protocol termination point; and

interface to said other protocol termination point based on a second protocol for transferring the protocol
15 initialization unit from the first termination point by means of the second protocol.

24. A network element according to claim 23, wherein the network element comprises a controller of a cellular
20 communication network.

25. A network element according to claim 23 or 24, wherein the control means for relocating are arranged to encapsulate the protocol initialization unit into a message to be
25 transmitted from the first termination point by means of the second protocol.

26. A network element according to any of claims 23 to 25, wherein the protocol initialization unit contains information
30 of at least one further protocol.

27. A network element for use in a communication network,
comprising:

a protocol termination point of a first protocol;

interface to another protocol termination point for

5 receiving a protocol initialization unit containing predefined
information of the first protocol at said other termination
point, wherein the interface is based on a second protocol;
and

10 control means for initializing the protocol termination
point based on the received protocol initialization unit.

28. A network element according to claim 27, wherein the
network element comprises a controller of a cellular
communication network.

15

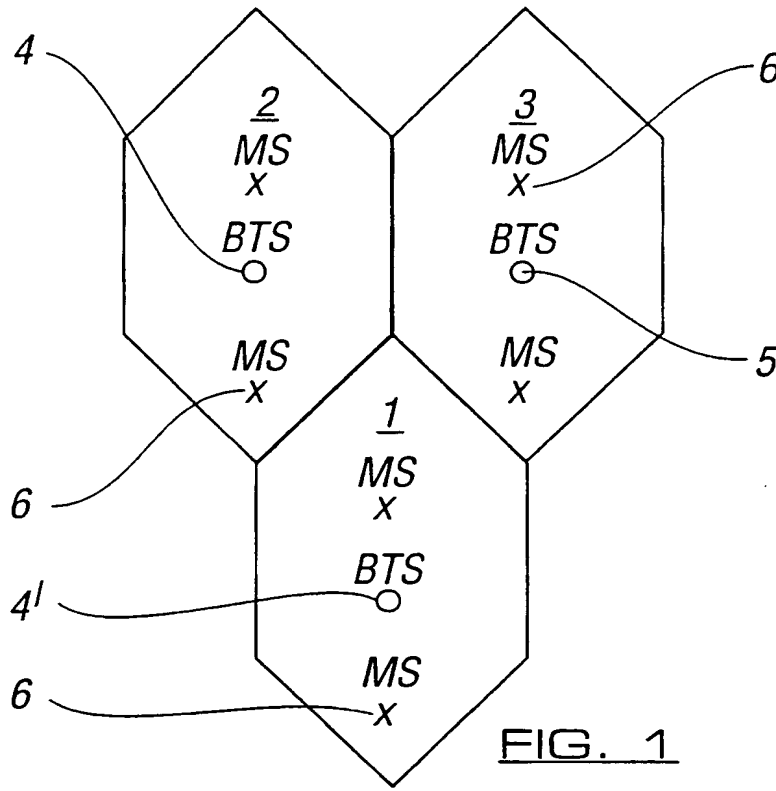

FIG. 1

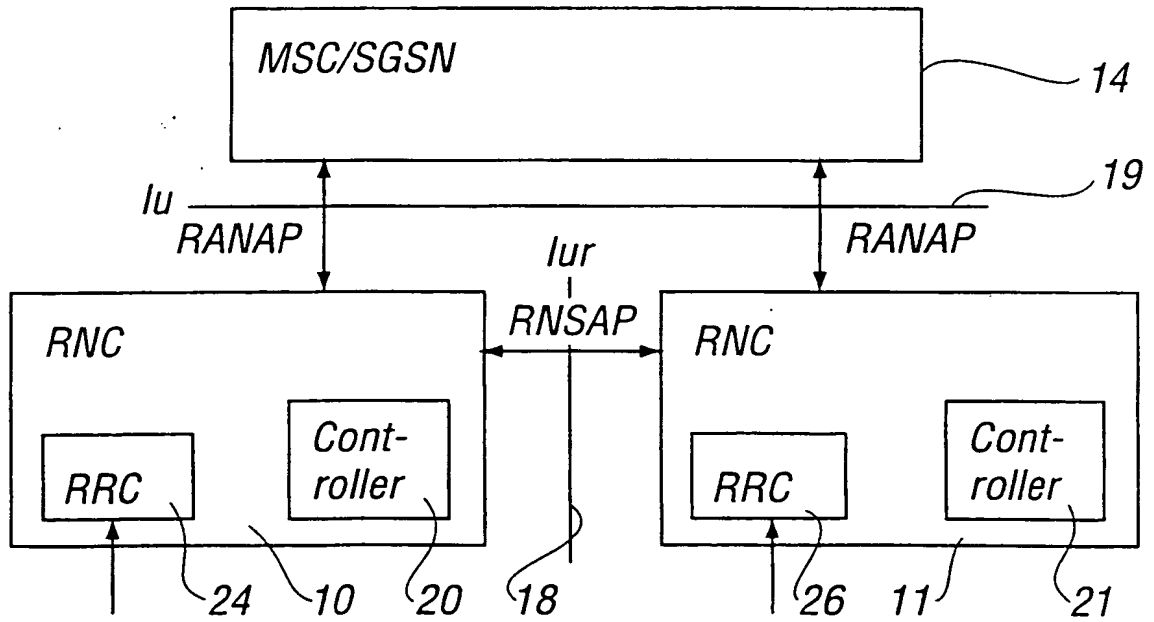

FIG. 3

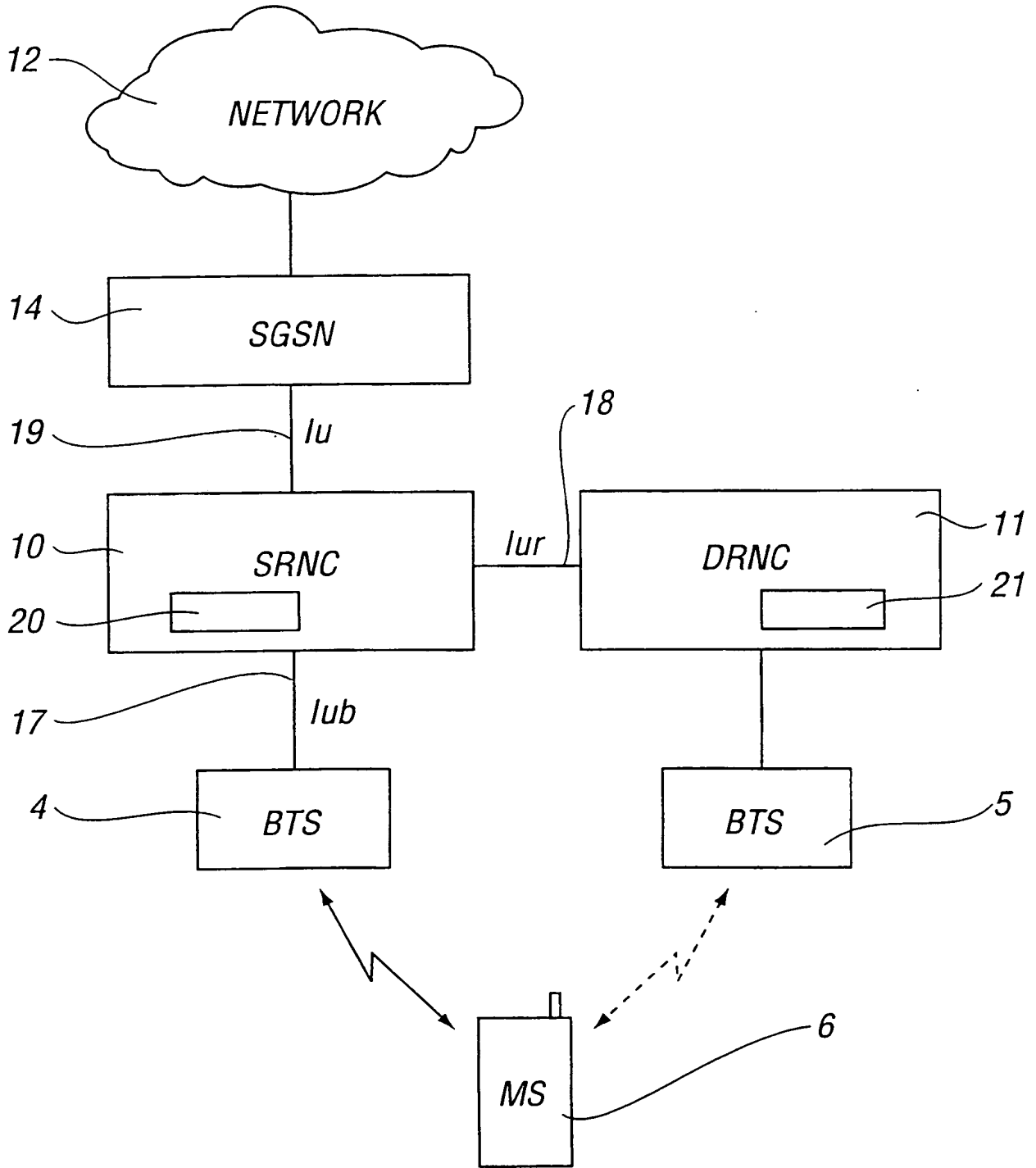

FIG. 2

3/3

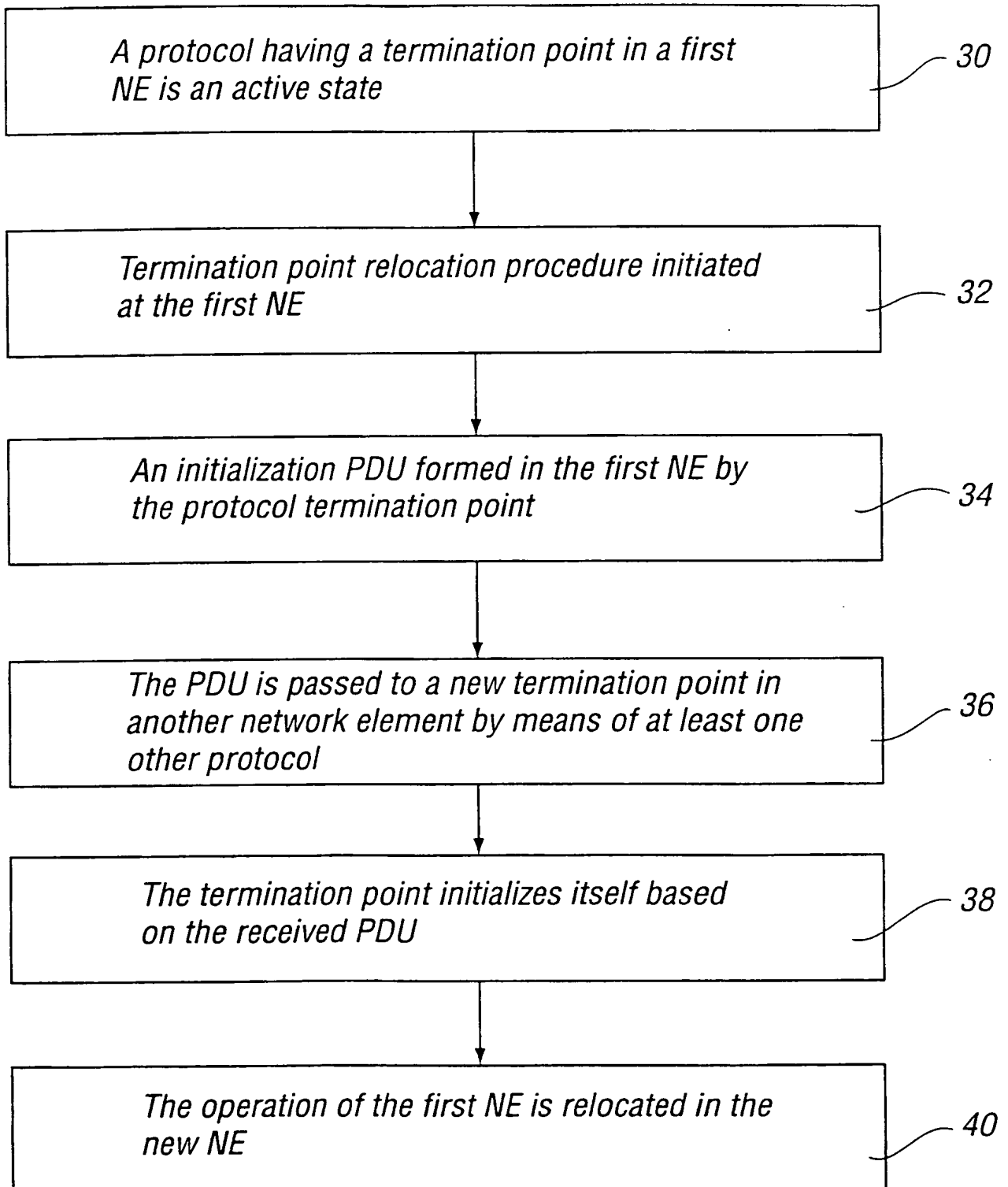

FIG. 4

INTERNATIONAL SEARCH REPORT

International Application No

PC 00/09100

A. CLASSIFICATION OF SUBJECT MATTER
IPC 7 H04Q7/38

According to International Patent Classification (IPC) or to both national classification and IPC

B. FIELDS SEARCHED

Minimum documentation searched (classification system followed by classification symbols)
IPC 7 H04Q

Documentation searched other than minimum documentation to the extent that such documents are included in the fields searched

Electronic data base consulted during the international search (name of data base and, where practical, search terms used)

EPO-Internal, WPI Data, INSPEC

C. DOCUMENTS CONSIDERED TO BE RELEVANT

Category °	Citation of document, with indication, where appropriate, of the relevant passages	Relevant to claim No.
X	EP 0 898 438 A (NOKIA MOBILE PHONES LTD) 24 February 1999 (1999-02-24) column 4, line 18 -column 5, line 22 column 8, line 1 - line 8 column 10, line 7 -column 11, line 49 figure 7	1-3, 5, 7, 9, 15-21, 23-25, 27, 28
A	CH 682 867 A (ASCOM TECH AG) 30 November 1993 (1993-11-30) column 7, line 19 -column 10, line 20 -/--	1, 3, 15, 17, 20, 21, 23, 24, 27, 28

Further documents are listed in the continuation of box C.

Patent family members are listed in annex.

° Special categories of cited documents :

- *A* document defining the general state of the art which is not considered to be of particular relevance
- *E* earlier document but published on or after the international filing date
- *L* document which may throw doubts on priority claim(s) or which is cited to establish the publication date of another citation or other special reason (as specified)
- *O* document referring to an oral disclosure, use, exhibition or other means
- *P* document published prior to the international filing date but later than the priority date claimed

- *T* later document published after the international filing date or priority date and not in conflict with the application but cited to understand the principle or theory underlying the invention
- *X* document of particular relevance; the claimed invention cannot be considered novel or cannot be considered to involve an inventive step when the document is taken alone
- *Y* document of particular relevance; the claimed invention cannot be considered to involve an inventive step when the document is combined with one or more other such documents, such combination being obvious to a person skilled in the art.
- *G* document member of the same patent family

Date of the actual completion of the international search

6 December 2000

Date of mailing of the international search report

12/12/2000

Name and mailing address of the ISA

European Patent Office, P.B. 5818 Patentlaan 2
NL - 2280 HV Rijswijk
Tel. (+31-70) 340-2040, Tx. 31 651 epo nl,
Fax: (+31-70) 340-3016

Authorized officer

Coppieters, S

INTERNATIONAL SEARCH REPORT

International Application No

PCT 00/09100

C.(Continuation) DOCUMENTS CONSIDERED TO BE RELEVANT

Category °	Citation of document, with indication, where appropriate, of the relevant passages	Relevant to claim No.
P,X	WO 99 51051 A (NOKIA TELECOMMUNICATIONS OY ;AHMAVAARA KALLE (FI)) 7 October 1999 (1999-10-07) page 3, line 4 - line 17 page 4, line 14 -page 6, line 20 claims 1,14 -----	1-3,5-7, 9,11-28

INTERNATIONAL SEARCH REPORT

Information on patent family members

International Application No

PC 00/09100

Patent document cited in search report	A	Publication date	Patent family member(s)	Publication date
EP 0898438	A	24-02-1999	FI 973425 A AU 7045198 A BR 9811247 A CN 1267440 T FI 990988 A WO 9909774 A JP 11113071 A	21-02-1999 08-03-1999 18-07-2000 20-09-2000 30-04-1999 25-02-1999 23-04-1999

CH 682867	A	30-11-1993	NONE	

WO 9951051	A	07-10-1999	FI 980736 A AU 3149699 A BR 9909307 A	01-10-1999 18-10-1999 21-11-2000

INTERNATIONAL PRELIMINARY EXAMINATION REPORT

(PCT Article 36 and Rule 70)

8

Applicant's or agent's file reference 102837/JPR		FOR FURTHER ACTION See Notification of Transmittal of International Preliminary Examination Report (Form PCT/IPEA/416)	
International application No. PCT/EP00/09100	International filing date (day/month/year) 13/09/2000	Priority date (day/month/year) 14/09/1999	
International Patent Classification (IPC) or national classification and IPC H04Q7/38			
Applicant [NOKIA NETWORKS OY et al.] <i>Nokia Corporation</i>			
<p>1. This international preliminary examination report has been prepared by this International Preliminary Examining Authority and is transmitted to the applicant according to Article 36.</p> <p>2. This REPORT consists of a total of 7 sheets, including this cover sheet.</p> <p><input type="checkbox"/> This report is also accompanied by ANNEXES, i.e. sheets of the description, claims and/or drawings which have been amended and are the basis for this report and/or sheets containing rectifications made before this Authority (see Rule 70.16 and Section 607 of the Administrative Instructions under the PCT).</p> <p>These annexes consist of a total of sheets.</p>			
<p>3. This report contains indications relating to the following items:</p> <ul style="list-style-type: none"> I <input checked="" type="checkbox"/> Basis of the report II <input type="checkbox"/> Priority III <input type="checkbox"/> Non-establishment of opinion with regard to novelty, inventive step and industrial applicability IV <input type="checkbox"/> Lack of unity of invention V <input checked="" type="checkbox"/> Reasoned statement under Article 35(2) with regard to novelty, inventive step or industrial applicability; citations and explanations supporting such statement VI <input type="checkbox"/> Certain documents cited VII <input type="checkbox"/> Certain defects in the international application VIII <input type="checkbox"/> Certain observations on the international application 			
Date of submission of the demand 28/03/2001		Date of completion of this report 05.03.2002	
Name and mailing address of the international preliminary examining authority:  European Patent Office D-80298 Munich Tel. +49 89 2399 - 0 Tx: 523656 epmu d Fax: +49 89 2399 - 4465		Authorized officer Hodgins, W Telephone No. +49 89 2399 8987	

CORRECTED
VERSION



I. Basis of the report

1. With regard to the **elements** of the international application (*Replacement sheets which have been furnished to the receiving Office in response to an invitation under Article 14 are referred to in this report as "originally filed" and are not annexed to this report since they do not contain amendments (Rules 70.16 and 70.17)*):

Description, pages:

1-17 as originally filed

Claims, No.:

1-28 as originally filed

Drawings, sheets:

1/3-3/3 as originally filed

2. With regard to the **language**, all the elements marked above were available or furnished to this Authority in the language in which the international application was filed, unless otherwise indicated under this item.

These elements were available or furnished to this Authority in the following language: , which is:

- the language of a translation furnished for the purposes of the international search (under Rule 23.1(b)).
- the language of publication of the international application (under Rule 48.3(b)).
- the language of a translation furnished for the purposes of international preliminary examination (under Rule 55.2 and/or 55.3).

3. With regard to any **nucleotide and/or amino acid sequence** disclosed in the international application, the international preliminary examination was carried out on the basis of the sequence listing:

- contained in the international application in written form.
- filed together with the international application in computer readable form.
- furnished subsequently to this Authority in written form.
- furnished subsequently to this Authority in computer readable form.
- The statement that the subsequently furnished written sequence listing does not go beyond the disclosure in the international application as filed has been furnished.
- The statement that the information recorded in computer readable form is identical to the written sequence listing has been furnished.

4. The amendments have resulted in the cancellation of:

- the description, pages:
- the claims, Nos.:

the drawings, sheets:

5. This report has been established as if (some of) the amendments had not been made, since they have been considered to go beyond the disclosure as filed (Rule 70.2(c)):

(Any replacement sheet containing such amendments must be referred to under item 1 and annexed to this report.)

6. Additional observations, if necessary:

V. Reasoned statement under Article 35(2) with regard to novelty, inventive step or industrial applicability; citations and explanations supporting such statement

1. Statement

Novelty (N)	Yes:	Claims	4,6,8,10-14,22,24,26
	No:	Claims	1-3,5,7,9,15-21,23,25,27,28
Inventive step (IS)	Yes:	Claims	
	No:	Claims	4,6,8,10-14,22,24,26
Industrial applicability (IA)	Yes:	Claims	1-28
	No:	Claims	

2. Citations and explanations
see separate sheet

Concerning Point V

1) The following documents are cited:

D1: EP-A-0 898 438 (NOKIA MOBILE PHONES LTD) 24 February 1999 (1999-02-24)

D2: CH 682 867 A (ASCOM TECH AG) 30 November 1993 (1993-11-30)

D3: WO 99 51051 A (NOKIA TELECOMMUNICATIONS OY ;AHMAVAARA KALLE (FI)) 7 October 1999 (1999-10-07)

2) Having carefully considered the applicant's arguments in the current case, the International Examining Authority has come to the conclusions set out below.

Although the applicant studiously avoids the term, the application essentially relates to handoff in a mobile communications (ie mobile phone) network. It is obvious that, in order to fully support a call, the "replacing network element" must support all protocols of the "replaced" one (and this will equally obviously be more involved in a multimedia UMTS network than in, say, a speech only network). The problem to be solved (as stated for example on page 10 lines 14 - 21) is thus obvious. Equally obvious is the fact that (either directly or indirectly) the replacing network element must receive the list of required settings (eg protocols) either from the replaced network element or from the mobile station. Since (especially with UMTS) increasing amounts of data are required for this, the latter would use scarce air waves. It is thus obvious to use the former and transfer the data via a link between the two network elements. This is effectively all that the current application describes and claims. Even without the "help" of prior art documents, the skilled man would find this obvious.

It is equally obvious that for any communications link (wired or wireless), protocols are used. The two ends of any communications link are thus protocol termination points. In fact, in the broad manner used in the current application, "protocol" could even be viewed as being synonymous to "communication". Moreover, as used in the discussion relating to figure 4 (page 11 line 29 - page 14 line 24) it is not even clear if the first and second protocols are actually different. However, regardless of this, what seems to be central to the current invention is that handoff of a mobile station MS 6 occurs from RNC 10 to RNC 11 (or more precisely from

RRC 24 in RNC 10 to RRC 26 in RNC 11). The protocol settings required by RRC 26 are sent from RRC 24 in an encapsulated message either by link 18 or via core network 14. Since these are wired, the protocol used on these will be different from that between the MS and the RNCs (RRCs). This is, however, exactly what happens in D1.

In this respect D1 discloses a method in a communication system for relocating a protocol termination point (see abstract and passages cited in search report).

The method of D1 comprises

defining a protocol initialization unit (the "encapsulated messages" shown in figure 7; cf corresponding part of description; see also the "Inter-GRAN handover shown in figure 6) containing predefined information of a first termination point of a first protocol by the first protocol;
transferring the protocol initialization unit from the first termination point (aRNC in figure 7) to a second termination point (bRNC in figure 7) by a second protocol; and
initializing the second termination point based on the protocol initialization unit (column 6 lines 36 - 40).

Accordingly, all features of claim 1 are known from D1 and the claim is thus not novel over D1 and thus fails to meet the requirements of Articles 33(1) and (2) PCT.

What the applicant seems to find of particular importance is the feature probably meant to be reflected in the claim language "of a first protocol by the first protocol". What exactly this wording means is not quite understood. It is, however, pointed out that the "protocol initialization unit" of D1 (ie the message sent from the first to the second RNC) is an encapsulated message. Moreover, even if the applicant were able, on the basis of such a detail to establish that claim 1 is novel, it is clear that, in such a case, the skilled man would be able to arrive at the claimed subject matter without performing an inventive step. In such a case, claim 1 would fail to meet the requirements of Articles 33(1) and (3) PCT.

- 3) Independent claim 17 relates for the apparatus category to method claim 1. Independent claims 23 and 27 are even broader than claim 17, since they relate merely to one part of the system.

The comments made above apply to these claims also, which are likewise not novel (or at the very least not inventive) over D1 and thus also fail to meet the requirements of Articles 33(1) and (2) PCT.

- 4) All of the dependent claims are either known from D1 or for the skilled man obvious in the light of D1 (see in particular figures 6 and 7 and related parts of description). Accordingly, they fail to meet the requirements of Articles 33(1) and (2) or (3) PCT.
- 5) The claimed invention is industrially applicable within the meaning of Articles 33(1) and (4) PCT.
- 6) For the sake of completeness, the following is noted:

- i) Certain published documents (Rule 70.10 PCT)

Although the above mentioned document D3 (publication date as above, filing date 31.03.99 and priority date 31.03.98) does not constitute prior art within the meaning of Rule 64.1(b) PCT, it seems to be of relevance when considering the novelty of the claims of the current application (see in particular passages cited in search report). No check has been made as to whether the priority of this prior application has been validly claimed.

- ii) The independent claims should have been put in the two part form recommended by Rule 6.3(b) PCT with a pre-characterising part reflecting the teachings of the closest prior art (eg D1).
- iii) In order to meet the requirements of Rule 6.2(b) PCT reference signs in parenthesis should have been added to the claims. This applies both to the preamble and to the characterising part, and to method claims in as far as they refer to apparatus features.

- iv) In order to meet the requirements of Rule 5.1(a)(ii) PCT, at least the document D1 should have been cited in the description and briefly discussed.

PATENT COOPERATION TREATY

PCT

INTERNATIONAL SEARCH REPORT

(PCT Article 18 and Rules 43 and 44)

Applicant's or agent's file reference 102837/JPR	FOR FURTHER ACTION see Notification of Transmittal of International Search Report (Form PCT/ISA/220) as well as, where applicable, item 5 below.	
International application No. PCT/EP 00/ 09100	International filing date (day/month/year) 13/09/2000	(Earliest) Priority Date (day/month/year) 14/09/1999
Applicant NOKIA NETWORKS OY		

This International Search Report has been prepared by this International Searching Authority and is transmitted to the applicant according to Article 18. A copy is being transmitted to the International Bureau.

This International Search Report consists of a total of 3 sheets.
 It is also accompanied by a copy of each prior art document cited in this report.

1. Basis of the report

a. With regard to the **language**, the international search was carried out on the basis of the international application in the language in which it was filed, unless otherwise indicated under this item.

the international search was carried out on the basis of a translation of the international application furnished to this Authority (Rule 23.1(b)).

b. With regard to any **nucleotide and/or amino acid sequence** disclosed in the international application, the international search was carried out on the basis of the sequence listing:

contained in the international application in written form.

filed together with the international application in computer readable form.

furnished subsequently to this Authority in written form.

furnished subsequently to this Authority in computer readable form.

the statement that the subsequently furnished written sequence listing does not go beyond the disclosure in the international application as filed has been furnished.

the statement that the information recorded in computer readable form is identical to the written sequence listing has been furnished

2. **Certain claims were found unsearchable** (See Box I).

3. **Unity of invention is lacking** (see Box II).

4. With regard to the **title**,

the text is approved as submitted by the applicant.

the text has been established by this Authority to read as follows:

5. With regard to the **abstract**,

the text is approved as submitted by the applicant.

the text has been established, according to Rule 38.2(b), by this Authority as it appears in Box III. The applicant may, within one month from the date of mailing of this international search report, submit comments to this Authority.

6. The figure of the **drawings** to be published with the abstract is Figure No.

as suggested by the applicant.

because the applicant failed to suggest a figure.

because this figure better characterizes the invention.

2
 None of the figures.